



**MANUAL DE USUARIO**  
UM MOTORCYCLES - SERIE RENEGADE 125 - EURO 5





# RENEGADE COMMANDO 125

MATT GREEN - GLOSSY BLACK - BLACK EDITION





# RENEGADE VEGAS 125

MATT BLACK





# RENEGADE FREEDOM 125

BLACK/GRAY







# RENEGADE CLASSIC 125

GLOSSY BLACK / COPPER CREAM





# RENEGADE CLASSIC DELUXE 125

GREEN BLACK / BLUE WHITE



## INTRODUCTION

Congratulations on choosing your New UM® 125 Series Renegade. By purchasing a new UM®, you become a part of worldwide family of satisfied customers; people who appreciate UM's commitment for building quality into every product.

Your 125 Series Renegade was designed as a street motorcycle. before riding, take time to get acquainted with you motorcycle and how it works. To protect your investment, we request to you to take responsibility for keeping your motorcycle well maintained. Scheduled service is a must, of course.

But it is just importan to observe the brake-in guidelines, and perform all the pre ride and other periodic checks detailed in this manual. The next 1000 kms are the most important for the life of your motorcycles engine. The proper usage during the first kilometers will achieve maximum life and maximum performance of your motorcycle. It is especially important that you do not operate the motorcycle in a manner that will cause engine over heating. We also recommend that you read the owners manual carefully before you ride. It is full of facts, instructions, safety information, and helpful tips.

If you have any questions, or if you ever need a special service or repairs, remember that your UM® dealer knows your motorcycle best and is dedicated to your complete satisfaction. Please report any change of address or ownership to your dealer so that we are able to contact you.

This manual should be considered a permanent part of the motorcycle and should remain with the motorcycle when it is resold.

This publication includes the latest production information available before printing. UM® Motorcycles reserves the right to make changes at any time without notice and without incurring any obligation.

\*The images printed here are only illustrative and this may vary from the product delivered depending on the model, cylinder capacity and country of Distribution.

**THANK YOU AND WELCOME  
TO THE WORLD OF UM<sup>®</sup>**

## IMPORTANT POINTS

### A FEW WORDS ON SAFETY

Your safety, and the safety of others, is the most important. Operating this motorcycle safely is an important responsibility.

To help you to get informed about safety decisions, we have provided operating procedures and other information in this manual. This information alerts you to potential hazards that could hurt you or hurt others. It does not and could not warn you about all hazards associated with operating or maintaining a motorcycle, thus you must use your own good judgment. You will find important safety information in a variety of forms, including:

- > Safety Labels - on the motorcycle.
- > Safety Messages - preceded by a safety alert symbol and one of the three signal words: DANGER, WARNING, or CAUTION.
- > Safety Headings - such as Important Safety Reminders or Important Safety Precautions.
- > Instructions - how to use this motorcycle correctly and safely - This entire book is filled with important safety information. Please read it carefully.



#### DANGER

You could be killed or seriously hurt if you don't follow instructions.



#### WARNING

You will be killed or seriously hurt if you don't follow instructions.



#### CAUTION

You can be hurt if you don't follow instructions.



## CONTENTS

RENEGADE MODELS AND COLORS	2
INTRODUCTION	12
IMPORTANT POINTS	14
VEHICLE IDENTIFICATION	16
IMPORTANT SAFETY INFORMATION	22
MODIFICATIONS	27
FUEL-SAVING TIPS	28
COMPONENT LOCATION & FUNCTION	29
INSTRUMENT PANEL	30
READY TO RIDE?	37
PRE-RIDE INSPECTION	38
BASIC OPERATION AND RIDING	39
ENGINE OIL	40
TECHNICAL SPECIFICATIONS	41
PERIODICAL MAINTENANCE & LUBRICATION CHART	46
TROUBLE SHOOTING	49
RECOMMENDATIONS	56
WARRANTY POLICY	57
WARRANTY REGISTRATION FORM	58

## VEHICLE IDENTIFICATION

This number completely identifies your vehicle. This number is used by all state, district, federal and government entities, for regulation, emission purposes and registration. This identification number is stamped on the chassis, and is located on the steering column. Furthermore, our warranty system is based on this identification number and the engine number.

Your engine number will be used by a UM® authorized dealer for vehicle identification purposes only. This number is stamped on the left engine case, below the shift pedal.

It is a crime to remove or tamper with the identification numbers. If there is any issue with either of these numbers, contact UM®. You need to safeguard the VIN number (vehicle identification number), as you may need it in case of registration issues, warranty claims, theft, or if there is a service bulletin or campaign.

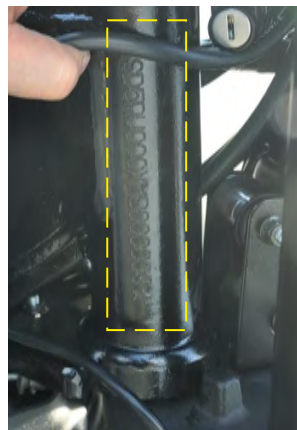

VEHICLE IDENTIFICATION NUMBER  
CHASSIS



VEHICLE IDENTIFICATION NUMBER  
ENGINE





## DIMENSIONS

RENEGADE COMMANDO





# DIMENSIONS

RENEGADE VEGAS





# DIMENSIONS

RENEGADE FREEDOM





# DIMENSIONS

RENEGADE CLASSIC





## DIMENSIONS

RENEGADE CLASSIC DELUXE



## IMPORTANT SAFETY INFORMATION

### WEAR PROTECTIVE GEAR

Your safety is very important. Your motorcycle can provide many years of service and pleasure, if you take responsibility for your own safety and understand the challenges while riding. There is much you can do to protect yourself when you ride. Please read through the following instructions before riding your motorcycle the first time.

- > Be sure you read this owner's manual completely and understand all operating features.
- > Take sufficient time training with safe and proper riding technique.
- > Practice until you are knowledgeable take sufficient time training with safe and proper riding technique.

Failure to follow any safety instructions could cause severe injury or even death to the motorcycle operator, passenger or pedestrians, Before riding each time, make sure of the following:

Riding a motorcycle leaves the rider exposed. Therefore, wearing appropriate protective gear can prevent or diminish injuries from accidents.

**Helmet** - The majority of serious motorcycle injuries and deaths are direct result of a head injury. Therefore, drivers and passengers should always wear a helmet to prevent or reduce the chance of head injury.

**Eye and Face Protection** - A plastic face shield can help prevent accidents by guarding the face and eyes from debris, allowing the rider to devote full attention to the road. Goggles or glasses can protect the eyes in the same manner.

**Clothing** - Bright clothing should be worn by the driver so as to be seen easily by other motorists. Avoid loose clothing that could catch on the levers, chain or wheels which could result in an accident. Gloves give you a better grip and help protect your hands.

## DO NOT RIDE WHILE UNDER THE INFLUENCE

Before getting on your motorcycle, make sure:

- > You have not consumed alcohol or taken drugs.
- > You are in good physical and mental condition.
- > You have done the recommended pre-ride inspection.
- > Start the engine in a well-ventilated area. The exhaust emits toxic and poisonous carbon monoxide.

## DO NOT RIDE WHILE UNDER THE INFLUENCE

- > Keep enough distance with the other vehicles around you, this gives to you time to react.
- > Always observe the rules of the road. Observe the posted speed limit, and signal your turns well in advance.
- > Know your limits. Do not go faster than you are able to control. Always travel at a speed that is proper to the operating conditions, your ability and experience.
- > Always inspect your motorcycle each time you use it to make sure it is at safe operating condition.

- > Always follow the inspection and scheduled maintenance procedures described in this manual.
- > Test your brakes after operating in wet conditions.
- > Never attempt wheelies, jumps and other stunts, as these could cause damage to the motorcycle and cause loss of control.
- > Always keep both hands on the handelbar and feet on the foot pegs during operation.
- > Never consume alcohol or drugs before or while riding your motorcycle.
- > Limit the travel distance to avoid fatigue taht can affect performance and awareness from the elements.
- > Do not touch the engine or exhaust after riding as they will be extremely hot right after the engine has been turned off.
- > Park the motorcycle away from fuel or flammable materials.

## BEING SEEN

Many motorcycle accidents are caused by car drivers who do not see motorcycle riders on the road. Therefore you need to follow these guidelines:

- > Wear bright clothing to increase visibility. Bright orange, yellow or green jackets or vests and a brightly colored helmet can help others see you.
- > Always use turn signals when you are planning to turn or merge to main roads, and turn it off after you have made your turn.
- > Flash brake lights whenever you are going to slow down quickly or where others may not expect you are going to slow down.
- > Stay out of blind spots of other motorists.
- > When you come to an intersection, move to the portion of your lane that will bring you into another driver's field of sight at the earliest possible moment.

## HOW TO KEEP YOUR MOTORCYCLE SAFE

The equilibrium and stability of your motorcycle are affected by the manner in which you load it. It is very important that you do not install accessories that change the design and concept of the motorcycle. Doing so could alter the safety of your motorcycle.

## LOADING & CARRYING PASSENGERS

You should avoid carrying passengers or large loads until you have gained sufficient experience riding alone. Extra weight changes handling, stability, braking performance, turns, acceleration and deceleration. The load you carry on the motorcycle has an important effect on your safety, as well as the life of the motorcycle; therefore, apart from driver and passenger, it is advised to keep load to a minimum. If you decide to carry any load, take the following into account:



- > Make sure the loads is as light and as small as possible.
- > Make sure the load does not interfere with any moving parts.
- > Make sure the load does not interfere with your ability to move around in order to maintain proper equilibrium.
- > Put the load as close as possible to the center of the motorcycle.
- > Put only light load on read rack, if installed.
- > Do not attach anything to handelbars, steering, headlight or front forks.
- > Strap everything properly.
- > Inflate tires properly.
- > Keep the load low and distribute the load evely. An uneven load can cause the motorcycle to drift to one side.

Carrying excess load on your motorcycle can cause an accident or crash resulting in severe injury or even death to the motorcycle operator, passenger or pedestrians.

To carry passengers safely, you must instruct the passenger before you start to:

- > Wear a helmet.
- > Get on the motorcycle after you have started the engine.
- > Sit as far forward as possible without crowding the driver.
- > Hold firmly to your waist, hips, belt or passenger handles.
- > Keep both feet on the pegs at all time, even when the motorcycle stopped.
- > Keeps legs away from hot and moving parts.\* Stay directly behind you, leaning as you lean.\* Avoid any unnecessary motion.

## LOADING & CARRYING PASSENGERS

- > Go slower.
- > Start slowing earlier as you approach a stop.
- > Maintain a large cushion of space ahead and to the sides.
- > Wait for large gaps when you want to across, enter or merge into traffic.

## PETROL AND EXHAUST FUMES

Petrol is highly flammable and exhaust fumes are poisonous:

- > Turn off engine before refueling.
- > Do not spill any Petrol on the engine, exhaust system or the plastic parts.
- > Do not refuel while smoking or near any open flame.
- > Do not operate your motorcycle in a closed area as the exhaust fumes may cause loss of consciousness or death within a short time.
- > Do not park the motorcycle near a flame source.
- > If you swallow Petrol, inhale Petrol vapor or spill Petrol in your eyes, see a doctor immediately or go to the nearest hospital.
- > If you spill Petrol on your clothes, change and wash the affected area immediately with soap.

## MODIFICATIONS

Any modifications to this motorcycle, removal of original equipment or use of unapproved accessories, may cause it to be unsafe for use and may trigger severe accidents. Some modifications may also make your motorcycle illegal to use on public roadways, and will void all warranty coverage.

Your dealer is familiar with all recommended accessories for your motorcycle, and should be consulted before installing any accessories. The owner of the motorcycle is responsible for the safety, installation and usage of any accessories not approved by UM®.

Before installing new accessories, make sure they do not interfere with moving parts, reduce ground clearance, and do not interfere with the operating controls.

### WEAR PROTECTIVE GEAR

The long term wear and duration of your motorcycle depends of the way you treat it during the first days of operation and the first 1000 kilometers. During this period, limit full throttle operation, and avoid driving at high speeds and any condition that may result in engine overheating. Do not exceed 65 Km during the initial running-in period

The recommended maximum speeds in kilometers per hour during the initial running in period, and the next 1000 kms are the following :

Kms.	1a.	2a.	3a.	4a.	5a.	5a.
0-1.000	15	30	45	55	65	75

- > Always stay within these limits during the break-in period.
- > Do not accelerate the engine excessively.
- > Do not move the motorcycle immediately after starting the engine. Allow the engine to warm up for a minute at low rpm so that proper lubrication reaches the top end of the motor.
- > Avoid letting the engine stall. Downshift before to maintain proper engine revolutions.



## FUEL SAVING TIPS

The way you drive your motorcycle will have a direct impact on your fuel consumption.

- > Driving at appropriate speed and avoiding sudden acceleration or braking, is not only important for your safety and fuel economy, but also to extend the usable life of your motorcycle and to achieve a smoother operation.
- > Driving within allowed limits inside the city will yield surprising fuel economy.
- > Always maintain tires at recommended pressure. Check pressure weekly.
- > Have your motorcycle inspected and serviced according to the periodic service and maintenance table.
- > Check that brakes are not dragging and preventing the wheels from turning freely. Avoid riding with the rear brake pedal pressed.
- > Turn off the engine if waiting for more than a few minutes.
- > Do not fill up fuel tank above cap neck.

## COMPONENT LOCATION & FUNCTION



### LEFT CONTROL

- 1 Clutch Lever
- 2 Horn Button
- 3 High and low beam switch
- 4 Turning Lights
- 5 Passing beam button

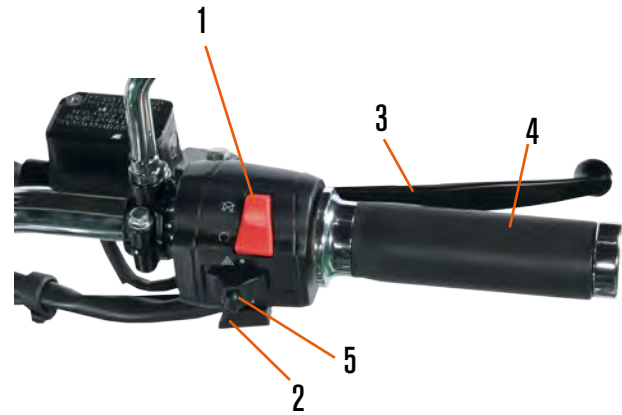

### RIGHT CONTROL

- 1 Engine kill switch
- 2 Start switch
- 3 Front brake lever
- 4 Throttle grip
- 5 Stationary Light

## INSTRUMENT PANEL

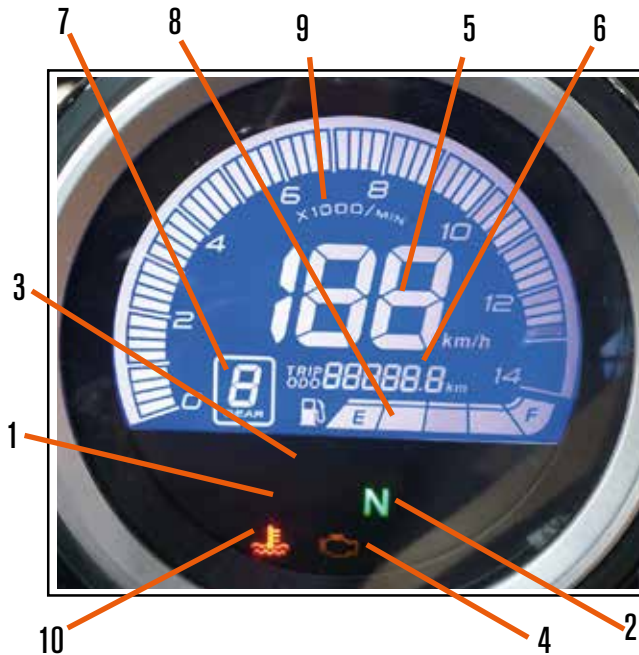

- 1 Directional Light: It will turn on when move the directional switch to the left or to the right.
- 2 Neutral light: Indicates when engine is in neutral and there is no gear engaged.
- 3 High Beam Indicator: It will turn on when the head light is in high beam position.
- 4 Check Engine Light: It is normal that it lighting when you turn on the ignition switch, but once engine start, the check engine light must be turn off, if keeps it lighting indicate malfunction of the computerized engine-management system.
- 5 Spedometer: Indicates the instantaneous speed of the motorcycle.
- 6 Odometer: Indicates accumulated distance.
- 7 Gear Position: Indicates the engine's gear position.
- 8 Fuel gauge: Indicates fuel level on.
- 9 Tachometer: Speed at which the motor rotates. This measurement is done in revolutions per minute, or RPM
- 10 Temperature Indicator.

## CHANGE SPEEDOMETER ODO TO TRIP OR TRIP TO ODO AND RESET INSTRUCTION

Turn the Key to ON position

Double press the passing beam button in three seconds and stay to change the model of ODO or TRIP.



Triple press the passing beam button in three seconds and stay to reset the trip data.



## CHANGE KMS TO MPH OR MPH TO KMS

Turn the Key to ON position

Press the passing beam button (see page 29) 4 times in 3s. and the hold to change KMS to MPH or MPH to KMS.



## IGNITION SWITCH

Ignition switch is fitted near handle bar. This key-operated switch has 3 positions: "ON", "OFF" & "Steering Lock"

## STEERING LOCK

In case of thieves, when you parking, please use this function. Turn the handle bar to left, press the key down and release, then turn the key to "🔒" position, it will lock handlebar. Then you can take out the key.

## KEY

The same key will operate the ignition switch, steering lock, fuel cap.





## FUEL TANK CAP

To open fuel cap :

- > Insert the key.
- > Turn key clockwise.

!CAUTION!

Do not mix the gasoline with any type of oil. To close the fuel cap, press cap down and make sure it is latched. Remove the key and fold the protecting tab down.



### DANGER

"Trying to operate motorcycle without properly fitted fuel cap can cause fuel leakage & may lead to serious problem"



### CAUTION

Do not mix fuel with any type of oil.

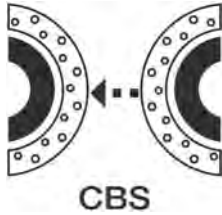

### COMBINED BRAKE SYSTEM

UM® 125 Series Renegade is equipped with combined brake system, which when you use the rear brake, the rear brake force is distributed and helps to brake with the front brake too, thus being softer and efficient the rear brake system.



### EFI BOSCH SYSTEM

It provides the engine with better performance with more economy in all operating regimes, and mainly less air pollution.



### CHECK ENGINE LIGHT

When you turn on the ignition switch it is normal that it is lighting (Check engine light), but if keeps it lighting once it is turn on the start switch, it is indicating malfunction, and need to be done a EFI diagnostic. Contact your UM® dealer as soon as possible to solve the problem.

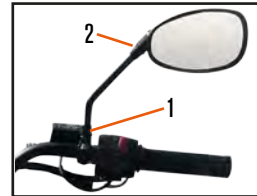

### ADJUSTABLE MIRROR

Turn the mirror 1 (1) and the mirror rod (2) can adjust the angle of mirror.



### 1. CLUTCH LEVER

The clutch lever located on the left side is used to disengage the transmission when vehicle is not moving, and for shifting gears. Pull lever in completely before shifting. Once gear has been engaged, slowly release the lever.

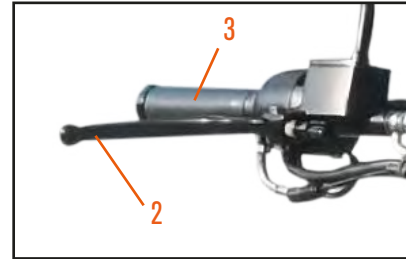

### 2. FRONT BRAKE LEVER

The front brake lever located on the right hand side is used to slow down or stop the vehicle. Take your time to learn some braking techniques, learn how use appropriate the combined brake system.

### 3. THROTTLE

The throttle controls engine rpm (speed). To increase engine rpm, rotate the grip toward you. To reduce engine rpm, rotate the grip away from you. The throttle will automatically return to the closed position (engine idle) when you remove your hand.



## REAR BRAKE PEDAL

The rear brake pedal is used to slow down or stop the vehicle. Besides UM® 125 Series Renegade is equipped with combined brake system, which when you use the rear brake, the rear brake force is distributed and helps to brake with the front brake too, thus being softer and efficient the rear brake system.

- 5 ↑
- 4 ↑
- 3 ↑
- 2 ↑
- N ↑
- 1 ↓



## GEAR SHIFT LEVER

The gear shift lever is used to select the next higher or lower gear in the transmission. To operate, raise the gear shift lever (after pulling in the clutch lever) to engage the next higher, or press the gear shift lever down to engage the next lower gear.

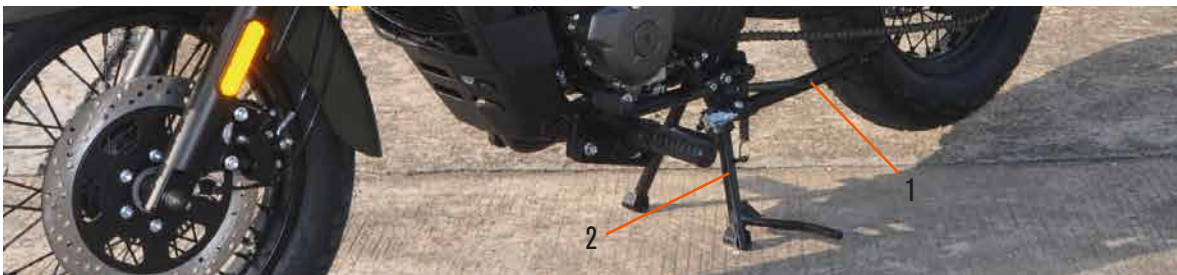

## 1. SIDE STAND

The side stand is used to support your motorcycle while parked. To operate, use your foot to lower the stand until it is fully extended. Raise the stand before riding.

## 2. CENTER STAND

The center stand should be used on level ground. It will permit lifting the rear wheel off the ground.

To operate, use your foot to lower the stand until it touches the ground, and raise the rear of the motorcycle while pushing the foot down. Fold the stand back before attempting to move the motorcycle.

## READY TO RIDE?

Are you ready to ride? Before riding, make sure you and your UM® 125 Series Renegade are both ready to ride:

- > Read and understand this manual carefully.
- > Take time to learn and practice. Start by practicing in a safe area and slowly build your skills.
- > Use highly visible and reflective clothing recommended for motorcycle riding.

### !CAUTION!

- > Don't ride when you are in poor physical or mental shape.
- > Don't drink and ride, alcohol and riding don't mix. Even one drink can reduce your ability to respond to changing conditions, and your reaction time gets worse with every additional drink.

## IS YOUR MOTORCYCLE READY TO RIDE?

Before each ride, it's important to inspect your motorcycle and make sure any problem you find is corrected. A pre-ride inspection is a must because road conditions can be very harsh on your motorcycle, and a pre-existing problem can let you down on the road, away from help.

Always perform a pre-ride inspection before every ride and correct any problems. Improperly maintaining this motorcycle or failing to correct a problem before riding can cause a crash in which you can be seriously hurt or killed.

# PRE - RIDE INSPECTION

INSPECT THE FOLLOWING ITEMS BEFORE YOU GET ON THE MOTORCYCLE

ITEM	ACTION
FUEL	Check fuel level and add enough for distance to ride. Close fuel cap properly.
LEAKS	Check for possible fuel leaks from the tank and oil leaks from the engine.
ENGINE OIL	Check oil level and add if necessary.
TIRES	Check tire pressure when tires are cool. Adjust tire pressure if necessary. Check for air leaks.
WHEELS	Check wheels for damage and verify that wheel axles are tight.
DRIVE CHAIN	Check chain for wear and tight spots. Check and adjust tension if necessary. Lube chain as needed.
CABLES	Check cables for wear or breaks.
NUTS & BOLTS	Check all accessible nuts and bolts and make sure they are tight.
THROTTLE	Check free play and adjust if needed. Rotate the throttle to make sure it moves freely and snaps shut automatically when it is released in all steering positions.
CLUTCH LEVER	Check for smooth operation and adjust if needed.
BRAKES	Squeeze the front brake lever and step on the rear brake pedal to check that the controls operate normally. Check for proper freeplay and adjust if necessary. Check front and rear pad wear. Check fluid level.
ELECTRICAL COMPONENTS	Check proper operation of headlight and taillight, check turn signals and brake light, check horn and electric starter.

## BASIC OPERATION AND RIDING

Before riding your motorcycle, please revise the safety messages given in the first pages of this manual. Even if you are a motorcycle rider, practice in a safe area and get accustomed to the weight of the motorcycle, your riding position for good equilibrium and the control operation of this motorcycle.

### STARTING & STOPPING THE ENGINE



#### WARNING

Trying to operate motorcycle with steering locked can cause serious injury and even death.

### STARTING & STOPPING THE ENGINE

Do not start the engine in an enclosed area. The exhaust fumes release toxic carbon monoxide that can cause disability or even death.

- > Sit on the motorcycle.
- > Insert the key in the ignition switch and unlock the steering.
- > Turn the switch ON.
- > Make sure motorcycle is in NEUTRAL.
- > Make sure that fuel valve is ON.
- > Press clutch lever.
- > Press switch to start the engine.
- > Release the starter button once the engine starts. If the starter is used for more than 5 seconds at a time, it could heat up and get damaged. If engine does not start, wait 10 seconds and try again.
- > Lift side stand up.



#### WARNING

Release the starter button once the engine starts. If the starter motor is kept running for more than 5 seconds at a time, it could overheat.





## ENGINE OIL

Check oil level weekly. Always keep oil level between the HI and LO mark. Add oil when is necessary. To check oil level:

- > Make sure engine is turned off for more than 3 minutes, otherwise level may not be accurate.
- > Put the motorcycle straight and on a level ground.
- > Check oil level by removing oil cap and checking on dip stick incorporated in cap.

Change engine oil every 3000 Km at an Authorised UM® Service Center. Recommended oil UM® Motorcycles: SJ 10W40.

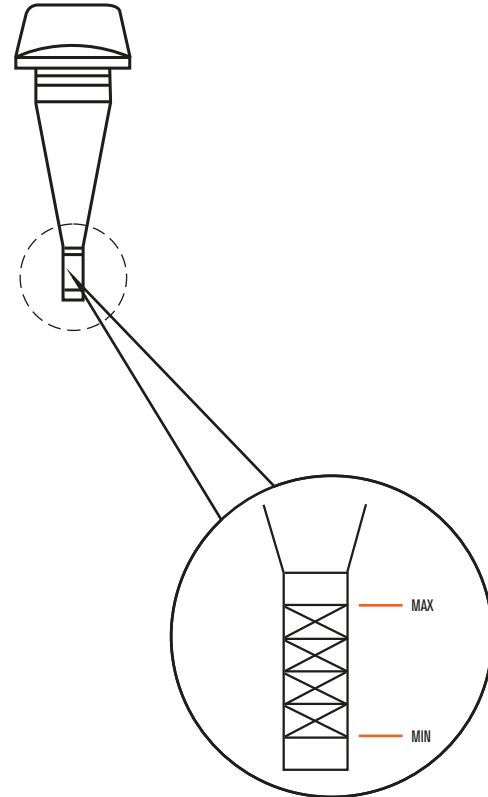



## TECHNICAL SPECIFICATIONS

RENEGADE COMMANDO 125

### ENGINE & TRANSMISSION

Engine Type	Single cylinder, 4-Stroke, DOHC
Valve	4 Valve
Displacement	124.2cc
Ignition	ECU
Fuel Delivery	EFI (BOSCH)
Max. Power	10 kW / 9500 rpm
Max. Torque	10.5 N.m. / 7500 rpm
Compression Ratio	12.0:1
Bore x Stroke	58.0 x 47.0 mm
Starter System	Electric Starter
Cooling System	Liquid Cooled
Transmission Type	Constant mesh 6-speed
Final Drive	428H Chain

### SUSPENSION, BRAKES & TIRES

Front Suspension	Universal, Hydraulic, $\Phi$ 41mm
Rear Suspension	Double Shock Absorber
Front Tire	110 / 90 - 16
Rear Tire	140 / 90 - 15
Brake System	CBS
Front Brake	Single disc + two-piston fork caliper
Rear Brake	Single disc + two-piston fork caliper

### OTHER SPECIFICATIONS

Weight	165 Kg.
Seat Height	770 mm
Height	1125 mm
Length	2270 mm
Width	840 mm
Ground Clearance	160 mm
Wheelbase	1530 mm
Fuel Tank Capacity	21 L.



## TECHNICAL SPECIFICATIONS

RENEGADE VEGAS 125

### ENGINE & TRANSMISSION

Engine Type	Single cylinder, 4-Stroke, DOHC
Valve	4 Valve
Displacement	124.2cc
Ignition	ECU
Fuel Delivery	EFI (BOSCH)
Max. Power	10 kW / 9500 rpm
Max. Torque	10.5 N.m. / 7500 rpm
Compression Ratio	12.0:1
Bore x Stroke	58.0 x 47.0 mm
Starter System	Electric Starter
Cooling System	Liquid Cooled
Transmission Type	Constant mesh 6-speed
Final Drive	428H Chain

### SUSPENSION, BRAKES & TIRES

Front Suspension	Universal, Hydraulic, $\Phi$ 41mm
Rear Suspension	Double Shock Absorber
Front Tire	110 / 80 - 17
Rear Tire	140 / 80 - 15
Brake System	CBS
Front Brake	Single disc + two-piston fork caliper
Rear Brake	Single disc + two-piston fork caliper

### OTHER SPECIFICATIONS

Weight	162 Kg.
Seat Height	770 mm
Height	1120 mm
Length	2260 mm
Width	840 mm
Ground Clearance	160 mm
Wheelbase	1530 mm
Fuel Tank Capacity	21 L.



## TECHNICAL SPECIFICATIONS

RENEGADE FREEDOM 125

### ENGINE & TRANSMISSION

Engine Type	Single cylinder, 4-Stroke, DOHC
Valve	4 Valve
Displacement	124.2cc
Ignition	ECU
Fuel Delivery	EFI (BOSCH)
Max. Power	10 kW / 9500 rpm
Max. Torque	10.5 N.m. / 7500 rpm
Compression Ratio	12.0:1
Bore x Stroke	58.0 x 47.0 mm
Starter System	Electric Starter
Cooling System	Liquid Cooled
Transmission Type	Constant mesh 6-speed
Final Drive	428H Chain

### SUSPENSION, BRAKES & TIRES

Front Suspension	Universal, Hydraulic, $\Phi$ 41mm
Rear Suspension	Double Shock Absorber whit gas reservoir
Front Tire	110 / 80 - 17
Rear Tire	140 / 80 - 15
Brake System	CBS
Front Brake	Single disc + two-piston fork caliper
Rear Brake	Single disc + two-piston fork caliper

### OTHER SPECIFICATIONS

Weight	162 Kg.
Seat Height	770 mm
Height	1125 mm
Length	2270 mm
Width	840 mm
Ground Clearance	160 mm
Wheelbase	1530 mm
Fuel Tank Capacity	21 L.



# TECHNICAL SPECIFICATIONS

RENEGADE CLASSIC 125

## ENGINE & TRANSMISSION

Engine Type	Single cylinder, 4-Stroke, DOHC
Valve	4 Valve
Displacement	124.2cc
Ignition	ECU
Fuel Delivery	EFI (BOSCH)
Max. Power	10 kW / 9500 rpm
Max. Torque	10.5 N.m. / 7500 rpm
Compression Ratio	12.0:1
Bore x Stroke	58.0 x 47.0 mm
Starter System	Electric Starter
Cooling System	Liquid Cooled
Transmission Type	Constant mesh 6-speed
Final Drive	428H Chain

## SUSPENSION, BRAKES & TIRES

Front Suspension	Universal, Hydraulic, $\Phi$ 41mm
Rear Suspension	Double Shock Absorber
Front Tire	110 / 90 - 16
Rear Tire	140 / 90 - 15
Brake System	CBS
Front Brake	Single disc + two-piston fork caliper
Rear Brake	Single disc + two-piston fork caliper

## OTHER SPECIFICATIONS

Weight	165 Kg.
Seat Height	770 mm
Height	1125 mm
Length	2270 mm
Width	840 mm
Ground Clearance	160 mm
Wheelbase	1530 mm
Fuel Tank Capacity	21 L.



## TECHNICAL SPECIFICATIONS

RENEGADE CLASSIC DELUXE 125

### ENGINE & TRANSMISSION

Engine Type	Single cylinder, 4-Stroke, DOHC
Valve	4 Valve
Displacement	124.2cc
Ignition	ECU
Fuel Delivery	EFI (BOSCH)
Max. Power	10 kW / 9500 rpm
Max. Torque	10.5 N.m. / 7500 rpm
Compression Ratio	12.0:1
Bore x Stroke	58.0 x 47.0 mm
Starter System	Electric Starter
Cooling System	Liquid Cooled
Transmission Type	Constant mesh 6-speed
Final Drive	428H Chain

### SUSPENSION, BRAKES & TIRES

Front Suspension	Universal, Hydraulic, $\Phi$ 41mm
Rear Suspension	Double Shock Absorber
Front Tire	110 / 90 - 16
Rear Tire	140 / 90 - 15
Brake System	CBS
Front Brake	Single disc + two-piston fork caliper
Rear Brake	Single disc + two-piston fork caliper

### OTHER SPECIFICATIONS

Weight	167 Kg.
Seat Height	770 mm
Height	1125 mm
Length	2270 mm
Width	840 mm
Ground Clearance	160 mm
Wheelbase	1530 mm
Fuel Tank Capacity	21 L.

## PERIODICAL MAINTENANCE & LUBRICATION CHART

The maintenance schedule described below is designed to maintain your UM® 125 Series Renegade Motorcycles to give an optimum performance & trouble free service. The vehicle must be serviced at every 3000 km or within 3 months whichever is earlier. All activities are laid down for average riding conditions. However depending upon rigorousness & dirt rides, the intervals of maintenance must be shortened.

No.	Description	Service		1st	2nd	3rd	4th	5th	6th	7th	8th	9th
		Whichever is Earlier		1	3	6	9	12	15	18	21	24
		Month	Km	1000	3000	6000	9000	12000	15000	18000	21000	24000
1	Engine oil	R	R	R	R	R	R	R	R	R	R	R
		Check level at every 1.000 Kms or earlier as required										
2	Engine oil filter element	R	R	R	R	R	R	R	R	R	R	R
3	Filter - oil strainer	I	I	I	C	I	I	C	I	I		
4	Air filter paper element	C	C	C	R	C	C	R	C	C		
5	Fuel filter	I	I	R	I	R	I	R	I	R	I	R
6	Spark plug	I	I	R	I	R	I	R	I	R	I	R
7	Pump fuel filter	Change at every 9.000 - 10.000 Km										
8	Accelerator cable play	I	I	I	I	I	I	I	I	I	I	
9	Clutch lever free play	I	I	I	I	I	I	I	I	I	I	
10	Fuel cap	I	I	C	I	C	I	C	I	C		

No.	Description	Service	1st	2nd	3rd	4th	5th	6th	7th	8th	9th
		Whichever is Earlier	1	3	6	9	12	15	18	21	24
		Month	1000	3000	6000	9000	12000	15000	18000	21000	24000
11	Hand levers pivot		L	L	L	L	L	L	L	L	L
12	Valve clearance inspection		I	I	I	I	I	I	I	I	I
13	Brake pedal inspection		L	L	L	L	L	L	L	L	L
14	Check battery voltage/terminals (Apply petroleum jelly)		I	I	I	I	I	I	I	I	I
15	Drive chain slackness / wear	Clean and lubrication at every 500 kms.									
16	Drive chain sider condition	Inspect at every 12.000 kms.									
17	Front fork oil leakage		I	I	I	I	I	I	I	I	I
18	Rear brake cam		L	L	L	L	L	L	L	L	L
19	Steering ball races/play adjustment		I	I	I	I	I	I	I	I	I
20	Spokes tightness & wheel rim run out front/rear		I	I	I	I	I	I	I	I	I
21	Rear wheel cush						I&R				I&R
22	Rubbers wheel bearing play						I				I
23	Swing arm bearing	Inspect at each service									
24	Tyre wear front / rear				I		I		I		I



No.	Description	Service		1st	2nd	3rd	4th	5th	6th	7th	8th	9th
		Whichever is Earlier		1	3	6	9	12	15	18	21	24
		Month	Km	1000	3000	6000	9000	12000	15000	18000	21000	24000
26	Brake oil level check /replacement	EVERY TWO YEARS										
27	Brake pad wear & disk wear	I	I	I	I	I	I	I	I	I	I	I
28	Brake light switch	I	I	I	I	I	I	I	I	I	I	I
29	Check al cables for damage / Sharp bend / routing	I	I	I	I	I	I	I	I	I	I	I
30	Side stand & main stand operation	I	I	I	I	I	I	I	I	I	I	I
31	Pivot-side stand, center stand, pillion foot rest	L	L	L	L	L	L	L	L	L	L	L
32	Suspension operation	I	I	I	I	I	I	I	I	I	I	I
33	Fuel tank	I	I	I	I	I	I	I	I	I	I	I
34	Nut, bolts, fasteners	I	I	I	I	I	I	I	I	I	I	I
35	All electrical functions	I	I	I	I	I	I	I	I	I	I	I
36	Leakage from Brake hose / Fuel hoses	I	I	I	I	I	I	I	I	I	I	I

**A: Adjust    C: Clean    I: Inspect    L: Lubricate    R: Replace**

Note :

1. Please repeat the maintenance schedule after 24,000 Kms with the same frequency specified above in consultation with a UM® Authorised Dealer Service Point.
2. Use UM® Genuine Oil Renegade Ignitor SAE 10W 40 while replacing engine oil. Recommended drain period is 3000 km
3. Periodical service Engine Oil Grade must be carried out at our Authorised dealer only as they have required special tools/expertise & Lubricants.

# TROUBLE SHOOTING

## 1. Vehicle not starting (does not crank)

• POSSIBLE CAUSES	• ACTIONS TO BE TAKEN
Ignition switch in "OFF" position	Switch on ignition
Engine kill switch in "OFF" position	Push stop switch to "ON" position
Vent hole clogged in fuel tank cap	Clean vent hole
HT Lead damaged	Replace HT Lead
Spark plug cap /lead not connected	connect the lead firmly
Spark plug loose	Tighten spark Plug
Failure of spark plug	If electrode dirty/ fouled-Clean & reset gap, Check & replace, if necessary
	If Spark plug insulation cracked - Replace spark plug
Starter motor not working	Check and replace if faulty
Starter motor not working & Battery not fully charged	Check & replace, if necessary
Clogged fuel line/pipe	Clean the fuel line/pipe
Clutch slipping	Adjust clutch cable free play
Loose connection and/or Starter relay not working	Check & replace, if necessary
Malfunctioning of clutch/ starter switch and battery discharge	Check & replace, if necessary

## 2. High Fuel consumption

• POSSIBLE CAUSES	• ACTIONS TO BE TAKEN
Under inflated tyres	Inflate to correct pressure
Fuel leakage	Check & adjust as per service manual
Breather system leakage	Check & rectify
Air filter	Clean / replace

Clutch Cable free play excessive & clutch slipping	Adjust cable free play
Brakes adjusted too tight	Re-adjust properly
Worn out Cyl-Piston parts	Change service limit exceeded parts
<b>3. Vehicle cranks but does not starts (Engine Misfiring)</b>	
<b>• POSSIBLE CAUSES</b>	<b>• ACTIONS TO BE TAKEN</b>
Water in petrol tank/ Fuel Line	Clean throttle body/Petrol tank, Fill the tank with fresh petrol
Loose/Leak through intake hose/line	Tighten rubber hose/line suitably, Replace if necessary
Loose spark plug	Fix cap/lead firmly
Spark plug fouled /insulation broken	Clean/reset gap or replace
Loose Connection in Ignition coil & suppressor cap	Ensure the all the connections
<b>4. Engine lacks power</b>	
<b>• POSSIBLE CAUSES</b>	<b>• ACTIONS TO BE TAKEN</b>
Faulty fuel supply	Clean the fuel line /pipes/vent holes
Clutch Cable free play excessive & clutch slipping	Adjust cable free play
Accelerator cable free play excessive	Adjust cable free play
Air filter	Clean/Replace air filter
Rear chain adjusted too tight	Re-adjust properly
Brakes adjusted too tight	Re-adjust properly
Under inflated tyres	Inflate to correct Tyre pressure as recommended

### 5. Engine overheating

• POSSIBLE CAUSES	• ACTIONS TO BE TAKEN
Transmission clutch slipping	Check & correct
Suction/Intake Syatem/parts leakage	Check & correct
Incorrect Fueling & Ignition Timing adjustments	Check & correct
Cylinder fins/ casting not clean/ clogged with mud, dirt	Clean the cylinder fins/ casting area
Silencer/ Exhaust System/ Parts leakage	Check & correct
Incorrect alarm connection	Check & correct

### 6. Starter motor doesnot work

• POSSIBLE CAUSES	• ACTIONS TO BE TAKEN
Ignition Key is OFF	Keep ignition key In ON condition
Kill switch OFF	Keep Kill switch in ON condition
Battery discharge	It should be more than 12.4 v, Charge if required
Fuse blown	Replace if found blown
Loose connection	Ensure the all the connectors are firmly connected to the wiring
Wiring hareness defective	Check the continuity of wiring harness starting circuit
Starter switch not working	Check the continuity
Starter relay is defective	Check the starter relay operation

### 7. Starter motor operates but engine doesn't starts

• POSSIBLE CAUSES	• ACTIONS TO BE TAKEN
Check engine clutch	Check & rectify
check engine starter gear	Check & rectify
Ignition system defective	Check spark by removing spark plug, If no spark then check ignition Circuit
Spark plug gap adjustment	Ensure the proper gap in spark plug

8. Starter motor struggles to crank	
• POSSIBLE CAUSES	• ACTIONS TO BE TAKEN
Battery discharge/ weak	Ensure the Battery voltage is more than 12.4 volt
Battery not fully charged	During cranking it should not be below 6 volt
Loose connection	Ensure the all the connectors are firmly connected with wiring
Malfunctioning of starter switch	Check & replace
Starter relay not working	Check & replace
Starter Motor defective	Check starter motor for any obstruction
9. Horn not working Horn sound not proper	
• POSSIBLE CAUSES	• ACTIONS TO BE TAKEN
Ignition Key is OFF	Keep Ignition Key in ON condition
Battery discharge	It should be more than 12.4 volt, Charge if required
Loose connection	Ensure all the connectors are connected with wiring
Fuse Blown	Replace if found blown
Incorrect screw adjustment	Set the horn by adjusting screw
10. No Fuel Indication/ Improper fuel	
• POSSIBLE CAUSES	• ACTIONS TO BE TAKEN
Ignition Key is OFF	Keep Ignition Key in ON condition
Loose Connection	It should be more than 12.4 volt, charge if required
Fuel sensor defective	Ensure the all the connectors are connected with the wiring
Battery discharge	Check the resistance of Fuel level sensor, replaced if found faulty

### 11. Battery is getting discharged

• POSSIBLE CAUSES	• ACTIONS TO BE TAKEN
Fuse Blown	Replace if found blown
Loose connection/ dust/ accumulation on negative terminal	Remove, clean and then connect Negative/ Earth terminal again
Battery defective	Check the battery charging
Regulator unit defective/ low output voltage	Crank the engine and check for regulator output voltage: >14V 2000RPM
Magneto coil defective	Confirm the magneto of coil resistances are within specifications, replace if required
Magneto coil short with ground	Confirm that there is no short circuit between ground and phases of coil

### 12. Engine Overheat

• POSSIBLE CAUSES	• ACTIONS TO BE TAKEN
Thermostat not working	Ensure the thermostat operation

### 13. Vehicle getting off in running (Engine Starts, But runs Irregularly & Stop/stall)

• POSSIBLE CAUSES	• ACTIONS TO BE TAKEN
Faulty fuel supply	Clean the fuel line/ tap/ vent hole4
Transmission Clutch slipping	Check and correct
Suction/ Intake System/ parts leakage	Check and correct

Incorrect Fueling & Ignition , Timing adjustments	Check and correct
Silencer/ Exhaust System/ parts leakage	Check and correct
<b>14. Lights are not illuminating</b>	
<b>• POSSIBLE CAUSES</b>	<b>• ACTIONS TO BE TAKEN</b>
Ignition key is off	Keep ignition key in ON condition
Battery discharge	It should be more than 12.4 volt, charge if required
Fuse Blown	Replace if found blown
Control switch not working	check the continuity
Bulb/LED fused	Replace if fused
Loose connection	Ensure all the connectors are firmly connected with wiring
wiring harness defective	Check the continuity of lighting the circuit in wiring harness
<b>15. Head Lamp illumination not proper</b>	
<b>• POSSIBLE CAUSES</b>	<b>• ACTIONS TO BE TAKEN</b>
Headlight setting disturbed	Follow the SOP for headlamp setting
Reflector dirty/damaged	Check for any damage or dark spots inside headlamp, reflector area, replace if required
Battery discharge	It should be more than 12.4 volt, charge if required
Regulator output voltage is low for discharge	Check the RR unit output voltage i.e, > 13.5 V, Replace if found Faulty
<b>16. Gear shifting hard</b>	
<b>• POSSIBLE CAUSES</b>	<b>• ACTIONS TO BE TAKEN</b>
Gear shift rod position incorrect	90 degree setting of gear shift rod
Excess play in clutch lever	Clutch lever to be adjusted
Clutch plates wornout	Replace clutch plates

17. Brakes poor	
• POSSIBLE CAUSES	• ACTIONS TO BE TAKEN
Not adjusted properly	Adjust properly
Oil/ Grease on lining or drum or disc	Clean and re-fit
Linings worn/ uneven wear	Replace linings
Disc scored/ uneven wear	Rectify or replace disc
18. Vehicle wobbles	
• POSSIBLE CAUSES	• ACTIONS TO BE TAKEN
Wheel rim runout	Rectify
Loose/ broken spokes	Tighten/ Replace spokes
Tyres not fitted correctly	Re-fit tyres correctly
Wheels misaligned	Ensure proper alignment
Under inflated tyres	Inflate to correct pressure
19. Trafficators not working	
• POSSIBLE CAUSES	• ACTIONS TO BE TAKEN
Loose/ improper connections	Check and correct
Bulb fused	Replace
Switch defective	Replace
Flasher defective	Replace
20. Brake light remains on	
• POSSIBLE CAUSES	• ACTIONS TO BE TAKEN
Switch not adjusted properly	Adjust switch properly
Switch sticky	Replace switch
Brake setting improper	Check & correct





## RECOMMENDATIONS

- > Always remember to check oil level...and do not exceed recommended level.
- > Be careful with recommended additive usage.
- > Always use recommended oil ratings or higher.
- > Change oil every 3000Km.
- > Do not wash motorcycle when engine is HOT. Be careful with electrical parts, and avoid using high pressure washers.
- > Do not puncture or make holes in the air box.
- > Replace air filter based on maintenance table recommendations.
- > Do not remove spark plug while engine is HOT.
- > Do not use non-recommended spark plugs, or spark plugs in poor condition.
- > Do not overload battery and charging system by adding too many electrical accessories.
- > Be careful when filling fuel tank for water not to get in.

- > When washing the motorcycle, avoid getting water in fuel tank, electrical system, exhaust and air filter.
- > Replace tires when service limit achieved,
- > Always check tire pressure.

## WARRANTY POLICY

UM® Motorcycles offers high quality products with excellent guarantee coverage, in a responsible and efficient way. We strive to ensure that our costumers recieve constant support and satisfactory after sales service.

from all our distributors. To obtain more information about our guarantee, contact your neares UM® Motorcycles dealer.



The general exclusions of this warranty shall include any damage caused by:

- > Accident
- > Use of the motorcycle in different conditions than the one it was designed for.
- > Use of spare parts, lubricants/coolants or supplies not approved by UM® Motorcycles and most of the cases described in the owners manual.
- > Changes in motorcycle system, technical modifications, modifying or repairing parts and the tempering of their controls.
- > Motorcycles used in any competition or engaged in renting, or which are disassembled.
- > Motorcycles used as a taxi service.
- > Damage caused intentionally or by external uncontrollable and/or cases considered as incidental.
- > Small failures not considered quality defects and that do not affect the normal performance of the motorcycle.

# WARRANTY REGISTRATION FORM

**OWNERSHIP & VECHICAL INFORMATION**



Customer Name : \_\_\_\_\_

Address : \_\_\_\_\_ Pin Code : \_\_\_\_\_

City : \_\_\_\_\_ State : \_\_\_\_\_ Country : \_\_\_\_\_

Mobile Number : \_\_\_\_\_ E-mail : \_\_\_\_\_

Frame No : \_\_\_\_\_ Model : \_\_\_\_\_

Engine No : \_\_\_\_\_ Color : \_\_\_\_\_

Battery Make : \_\_\_\_\_ Battery Sr. No/Code : \_\_\_\_\_

Tire Make : \_\_\_\_\_ Tire No : \_\_\_\_\_

Date of Sale : \_\_\_\_\_ KM : \_\_\_\_\_ Key No : \_\_\_\_\_

Dealer Name : \_\_\_\_\_

Location : \_\_\_\_\_ Code No : \_\_\_\_\_

Reg No : \_\_\_\_\_ Contact No : \_\_\_\_\_

The UM® Motorcycles dealers are required to register the sale of the motorcycle with up to date information regarding the original owner, in order to activate the warranty. If the owner of the vehicle has changed, please submit an "Owner Registration" from via fax or regular mail. This information is necessary for notification, in case your motorcycle is affected by a service bulletin or campaign.

\_\_\_\_\_  
Dealer Name & Address, Stamp

1) Customer Copy:

\_\_\_\_\_  
Customer Signature

## VEHICLE INSTALLATION AND DELIVERY CERTIFICATE :

Frame No : \_\_\_\_\_ Engine No: \_\_\_\_\_

### INFORMATION TO CUSTOMER (TO BE EXPLAINED BY DEALER)

1. Warranty policy
2. Important of periodical maintenance / schedule
3. Oil level checking procedure
4. Operation of breaks
5. Fuel gauge
6. Combined braking system
7. Safe riding advice
8. Battery maintenance
9. Tire pressure
10. Check engine light (EFI diagnostic)
11. Vehicle parking & locking
12. Cleaning & Lubrication of drive chain

- Above vehicle was inspected / test driven by me / my representatives at the time of delivery and found to be acceptable and free from any operational/visual defects.
- I understand that my warranty claims if any, will be considered by the manufacturer in accordance with the scope and limit of the warranty as specified.

1) **Customer Copy :**

\_\_\_\_\_ **Customer Signature**

Place:

Date:

\_\_\_\_\_ **Dealer Name & Address, Stamp :**

# WARRANTY REGISTRATION FORM

## OWNERSHIP & VEHICAL INFORMATION



Customer Name : \_\_\_\_\_

Address : \_\_\_\_\_ Pin Code : \_\_\_\_\_

City : \_\_\_\_\_ State : \_\_\_\_\_ Country : \_\_\_\_\_

Mobile Number : \_\_\_\_\_ E-mail : \_\_\_\_\_

Frame No : \_\_\_\_\_ Model : \_\_\_\_\_

Engine No : \_\_\_\_\_ Color : \_\_\_\_\_

Battery Make : \_\_\_\_\_ Battery Sr. No/Code : \_\_\_\_\_

Tire Make : \_\_\_\_\_ Tire No : \_\_\_\_\_

Date of Sale : \_\_\_\_\_ KM : \_\_\_\_\_ Key No : \_\_\_\_\_

Dealer Name : \_\_\_\_\_

Location : \_\_\_\_\_ Code No : \_\_\_\_\_

Reg No : \_\_\_\_\_ Contact No : \_\_\_\_\_

The UM® Motorcycles dealers are required to register the sale of the motorcycle with up to date information regarding the original owner, in order to activate the warranty. If the owner of the vehicle has changed, please submit an "Owner Registration" from via fax or regular mail. This information is necessary for notification, in case your motorcycle is affected by a service bulletin or campaign.

\_\_\_\_\_  
Dealer Name & Address, Stamp

2) Customer Copy:

\_\_\_\_\_  
Customer Signature

## VEHICLE INSTALLATION AND DELIVERY CERTIFICATE :

Frame No : \_\_\_\_\_ Engine No: \_\_\_\_\_

### INFORMATION TO CUSTOMER (TO BE EXPLAINED BY DEALER)

1. Warranty policy
2. Important of periodical maintenance / schedule
3. Oil level checking procedure
4. Operation of breaks
5. Fuel gauge
6. Combined braking system
7. Safe riding advice
8. Battery maintenance
9. Tire pressure
10. Check engine light (EFI diagnostic)
11. Vehicle parking & locking
12. Cleaning & Lubrication of drive chain

- Above vehicle was inspected / test driven by me / my representatives at the time of delivery and found to be acceptable and free from any operational/visual defects.
- I understand that my warranty claims if any, will be considered by the manufacturer in accordance with the scope and limit of the warranty as specified.

### 2) Customer Copy :

\_\_\_\_\_ **Customer Signature**

Place:

Date:

\_\_\_\_\_ **Dealer Name & Address, Stamp :**

# WARRANTY REGISTRATION FORM

OWNERSHIP & VEHICAL INFORMATION	
	
Customer Name :	_____
Address :	_____ Pin Code : _____
City :	_____ State : _____ Country : _____
Mobile Number :	_____ E-mail : _____
Frame No :	_____ Model : _____
Engine No :	_____ Color : _____
Battery Make :	_____ Battery Sr. No/Code : _____
Tire Make :	_____ Tire No : _____
Date of Sale :	_____ KM : _____ Key No : _____
Dealer Name :	_____
Location :	_____ Code No : _____
Reg No :	_____ Contact No : _____

The UM® Motorcycles dealers are required to register the sale of the motorcycle with up to date information regarding the original owner, in order to activate the warranty. If the owner of the vehicle has changed, please submit an "Owner Registration" from via fax or regular mail. This information is necessary for notification, in case your motorcycle is affected by a service bulletin or campaign.

\_\_\_\_\_  
Dealer Name & Address, Stamp

3) Customer Copy:

\_\_\_\_\_  
Customer Signature

## VEHICLE INSTALLATION AND DELIVERY CERTIFICATE :

Frame No : \_\_\_\_\_ Engine No: \_\_\_\_\_

### INFORMATION TO CUSTOMER (TO BE EXPLAINED BY DEALER)

1. Warranty policy
2. Important of periodical maintenance / schedule
3. Oil level checking procedure
4. Operation of breaks
5. Fuel gauge
6. Combined braking system
7. Safe riding advice
8. Battery maintenance
9. Tire pressure
10. Check engine light (EFI diagnostic)
11. Vehicle parking & locking
12. Cleaning & Lubrication of drive chain

- Above vehicle was inspected / test driven by me / my representatives at the time of delivery and found to be acceptable and free from any operational/visual defects.
- I understand that my warranty claims if any, will be considered by the manufacturer in accordance with the scope and limit of the warranty as specified.

### 3) Customer Copy :

\_\_\_\_\_

Customer Signature

Place:

Date:

\_\_\_\_\_

Dealer Name & Address, Stamp :



For you to know the list and information about the different Distributors, Authorized Service Centers and warehouses where they sell original UM® parts and spare parts, request it from your UM® Distributor in each country or if you prefer, you can consult our website:

[www.ummotorcycles.com](http://www.ummotorcycles.com)



# RENEGADE



**RENEGADE**  
VEGAS



RENEGADE COMMANDO  
*Classic Deluxe*

FEEL <sup>the</sup>  
FREEDOM

The image features the text "FEEL the FREEDOM" in a vibrant orange color. "FEEL" is in a large, bold, serif font. "the" is written in a smaller, cursive script font, positioned above the end of "FEEL" and underlined with three horizontal lines. "FREEDOM" is in a large, bold, serif font, with a wavy flourish underneath the "F" and a horizontal flourish under the "D". A hand-drawn arrow with a feathered tail points from the "D" towards the right. The entire composition is set against a white background with four black corner brackets.





USA ORIGINATED

[www.ummotorcycles.com](http://www.ummotorcycles.com)